

Pares - Marami

Manuale installazione

Installation manual
Installationshandbuch
Notice d'installation
Manual para la instalación
Manual de instalação
Installatiehandleiding
Εγχειρίδιο οδηγιών τοποθέτησης
Руководство по установке
Priročnik za montažo
Priručnik za montaž



Manuale d'uso

Instructions for operation
Gebrauchsanweisung
Instructions d'utilisation
Manual para el uso
Manual de uso
Gebruikershandleiding
Εγχειρίδιο οδηγιών χρήσης
Руководство по пользованию
Priročnik za uporabo
Priručnik za upotrebu



albatros

I D R O E M O Z I O N I

TABLE OF CONTENTS

1.	Warning and advice	2
1.1	Important safety warnings	3
1.2	Installation advice.....	5
2.	Commissioning of SpaPack (Marami with SpaPack only)	7
2.1	Safety Warning for sand filter	7
2.2	Safety Warning for prefilter pump ter	7
2.3	Warning for installation and assembly tasks	7
2.4	Connection of your SpaPack (hydraulic & electric)	8
3.	Commissioning of spas	11
3.1	Electrical connections	11
3.2	Filling the spa	13
3.3	Switching on the power	15
3.4	Installation of the isothermal cover.....	16
3.5	Initial treatment of the water.....	16
4.	Use of the spa	16
4.1	Presentation of PARES.....	16
4.2	Presentation of MARAMI	17
4.3	PARES	18
4.4	MARAMI	18
4.5	Operation of the sand filter (Marami with SpaPack only)	19
4.6	Operation of the prefilter pump (Marami with SpaPack only)	21
4.7	Operation of the spa	22
5.	Maintenance of the spa	27
5.1	Cleaning the cartridges.....	27
5.2	Draining and filling the spa	27
5.3	Upkeep of the inside surface of the spa	28
5.4	Upkeep of headrests.....	28
5.5	Upkeep of the spa cover.....	28
5.6	Upkeep of the surround made of synthetic material	28
5.7	Winterizing.....	28
5.8	Restarting your spa during the cold season	29
5.9	Preservation of the quality of the water.....	29
5.10	Checking of the pH of the water.....	29
5.11	Purification of the water.....	29
5.12	Discharge ozonisation system.....	29
6.	Limited warranty	30
7.	Fault finding guide	30

1. Warning and advice

Important information for the owners of Spas

Your spa was designed and manufactured with the utmost care to ensure you many years of carefree operation.

In order to preserve all its original qualities and prevent any irreversible damage to this spa, the exposure of the surfaces of the spa to direct sunlight or high temperatures during a prolonged period of time is advised against. Any damage caused by such excessive exposure is not covered by the warranty.

When the spa is installed in a position directly exposed to sunlight, we recommend keeping it filled with water and keeping its isothermal cover permanently fitted when the spa is not in use.

Read the recommended installation conditions in the installation manual and make sure they are properly complied with.

Our factory always endeavours to improve the performances of its spas. For this reason, it is possible that certain modifications and improvements do not figure in the present documentation, illustration and/or instructions. The photos and illustrations in this document are not contractual.

To be read carefully and kept for subsequent consultation.

You have just purchased a spa from our range and we thank you for your trust. This is an efficient and reliable product with a high level of performance.

This spa was designed and manufactured with our utmost care in order to give you relaxation and pleasure. However, its use calls for precautions which you must be aware of.

Before installing and using it, read the following information carefully. It contains important recommendations about the various operations and advice on how to use the spa.

Keep this information safely and show it to any users of the spa.

1.1 *Important safety warnings*

Read all these instructions and follow them to the letter.

Basic safety precautions must always be taken when installing and using this electrical appliance. These include:

DANGER: In order to prevent accidents, make sure that children cannot use the spa without being constantly supervised by responsible adults

DANGER: Risk of injury. The suction parts of this spa are qualified to withstand the water flow required for the pumps. Should you have to change them, make sure of the compatibility of any new parts fitted. Never operate the spa if the suction grids are blocked up, damaged or missing.

DANGER: Risk of electric shock. Prohibit the use of any electrical appliance such as a lamp, radio set, telephone, television set etc. at a distance of less than 1.5 m from the spa, unless such an appliance is included in the spa by the manufacturer.

In order to reduce the risk of injuries to a minimum:

WARNING: Enter and leave the spa slowly and cautiously. The wet surfaces may be very slippery.

WARNING: Do not use the spa immediately after great exertion.

WARNING: Use the spa cautiously. Prolonged exposure to high temperatures can raise body temperature and possibly cause dizziness, sickness, fainting, somnolence, lowering of the state of consciousness.

WARNING: Always check the temperature of the spa before entering.

WARNING: The water temperature of the spa must never exceed 40°C. A temperature of between 34°C and 40°C is deemed to be harmless for adults in good health. In the event of use with young children or elderly people, it is advisable to reduce the water temperature.

WARNING: For use by a pregnant woman, we recommend having a maximum temperature of 38°C. If you are pregnant, please consult your doctor before using the spa.

WARNING: In the case of people who may be particularly sensitive to the temperature of the spa water (children, pregnant women, elderly people), we recommend checking the temperature of the spa water with a thermometer (the precision of the spa's temperature regulating equipment may produce a variation in the water temperature of $\pm 2^\circ\text{C}$).

WARNING: The consumption of alcohol, drugs or medicines before or during the use of the spa may cause a loss of consciousness or risks of drowning.

WARNING: People taking medication must consult their doctor before using the spa.

WARNING: People suffering from obesity or who have a medical history of heart disease, high or low blood pressure, circulation problems, diabetes, infectious disease or a deficiency syndrome of the immunity system must consult a doctor before using a spa. Should the use of the spa create breathing difficulties for you, stop using it and consult your doctor.

WARNING: Always take a shower before and after using the spa in order to reduce the risk of contracting an infectious disease transmitted through the water. Always maintain the chemical balance of your spa water by using adequate products. Should a user contract such a disease, stop using your spa and consult a doctor.

WARNING: Prohibit pets from entering the spa area.

WARNING: Always maintain the chemical balance of your spa water within the range of parameters recommended by swimming pool and spa professionals:

- pH 7.2 - 7.4
- Free chlorine 3-5 ppm
- Free bromine 4-6 ppm
- Total alkalinity 100-120 ppm
- Calcium hardness 150-250 ppm

Instructions for installation and operation - English

WARNING: In order to guarantee healthy spa water, always maintain the filter as per the instructions of the spa manufacturer. Your spa is equipped with a high-performance water filtration system that gives you water of exceptional quality. In order to guarantee the obtainment of water of optimum quality on a permanent basis, clean the cartridge of the filter at least every two months or more often if necessary. In order to obtain the detailed instructions for the cleaning and refitting of the cartridge. For complete description refer to chapter 5.1.

WARNING: Change the spa water regularly. The water change frequency required depends on a number of variables such as the frequency of use, the number of users, the chemical balance of the water and the maintaining of the water quality done. Change the water when you notice a loss of clearness of the water even if the water quality measurements specified all comply with the recommended criteria (at the worst every 3 months).

WARNING: Before cleaning the filtration cartridges, switch off the spa power supply.

1.2 *Installation advice*

ACCESS TO THE LOCATION - DELIVERY

Ensure the accessibility of the point of delivery and the possibility of transporting the spa on a trolley to its point of installation. Make sure there are no obstacles (wall, hedge, gate, steps...) and inform your dealer before delivery.

Transport the spa carefully to the intended installation point. Four people are generally needed to perform this operation properly.

UNPACKING

Make sure you do not scratch the shell by using sharp instruments to unpack the spa. Start by puncturing the packaging in the middle of the spa (on the empty volume).

PREPARATION OF THE SUPPORT BASE

Make sure that the support base is properly level.

If the spa is installed outside (for example on a lawn), make the support base with a stabilized bottom that will guarantee its stability and **withstand a load of 400kg/m² for PARES and a load of 600kg/m² for Marami**.

We recommend pouring a 10cm thick concrete slab.

If the spa is placed on a surface that does not meet these requirements, damage to the shell, structure or the surrounds of the spa could occur. Any damage caused by an inadequate base is not covered by the warranty of the manufacturer. It is the responsibility of the owner of the spa to ensure the integrity of the support base over the course of time.

SEMI-EMBEDDED INSTALLATION

Make sure that only the base of the spa is embedded and that the side panels remain clear. For this type of installation, we recommend providing a clearance of approximately 40cm and installing removable platforms (made of marine plywood or other material) that not only finish off the installation from an aesthetical standpoint, but which also enable the panels to be removed more easily in the event of after-sales service.

INSTALLATION INDOORS

In the case of installation indoors, it is necessary to make allowance for the fact that water evaporation can lead to a big increase in the level of humidity. Natural or forced ventilation contributes to maintaining the level of comfort and preventing damage caused by humidity in the home.

The manufacturer declines any liability in the event of damage due to an excessive level of humidity, leaks or water overflow. We recommend you use a qualified installer.

PREPARATION OF THE HYDRAULICAL CONNECTIONS

DRAINAGE: The spa is equipped with a bottom valve with a 40 mm dia connection. To drain the water, connect a hose up to the valve or make a fixed connection with the drain pipe. You can also use an independent system to be fitted with precaution in the spa (immersed pump or water aspirator). Before draining the water off into the public drainage system, check the local regulations in force.

FILLING: In order to fill the spa, it is advisable to use a hose and position one end in the filtration skimmer. It is imperative to fill the spa at its final location. Moving a spa filled with water is prohibited and is likely to cause irreparable damage not covered by our warranty.

PRE-WIRING OF ELECTRICAL CONNECTIONS

The electrical installation for the spa is the customer's responsibility. Under no circumstances are our teams authorised to carry out work on the customer's electrical installation. We recommend you call upon the services of a certified electrician to ensure compliance of your installation. The installer should refer to standards.

See also the following documents:

- **Product technical sheet**
- **Electrical system, safety distances and danger zones for SPA pools with hydromassage**

It is the installer's responsibility to choose the materials according to the planned use, to make sure the works are carried out properly, to check the state of the installation to which the appliance is connected, and also to ensure its compliance with the safety standards to be applied during its use and during the maintenance operations, making sure that the installation can be checked easily.

The power supply installation must comply with the provisions of the national legislation. The spa must be permanently connected, without any intermediate connections, to the electric power supply network and to the protection circuit (grounding).

The spa must be fed without fail through a differential circuit-breaker with a release threshold of 30mA. For the grounding connection provided for by the directives in force, the installer must use the terminal provided for this purpose on the electrical box. More specifically, it is necessary to guarantee the equipotentiality of all the metal masses located close to the spa.

The connection to the mains must include the grounding connection and be:

- of the fixed type
- sized for maximum consumption (as shown on the table of the electrical characteristics).
- with a level of resistance to liquid penetration (IPX5) in accordance with standards.

This appliance is intended for home use. In the event of public use, guarantee, in addition to the technical and safety provisions stipulated by our factory, total compliance with the standards of specific laws for the circuit, safety and treatment of the water in force in the country where the spa is to be installed.

2. Commissioning of SpaPack (Marami with SpaPack only)

2.1 *Safety Warning for sand filter*

WARNING: Never start up the system without water.

WARNING: Whenever you operate the filter or the selector valve, switch off the pump first.

WARNING: Never allow children or adults to sit on the system.

WARNING: Do not connect the filter directly to the water network, as the pressure of the water may be too high and exceed the maximum work pressure allowed by the filter.

WARNING: Do not clean the lid with solvents, as it may damage its properties (finish, transparency...).

WARNING: As all the connections are made with joints, it is not necessary to tighten the nuts excessively in order to avoid that some plastics pieces could break.

2.2 *Safety Warning for prefilter pump ter*

WARNING: This pump is specially designed for the prefiltering and recirculation water in spa.

WARNING: It is designed to work with clean water at a temperature of not over 40°C.

WARNING: The installation must be carried out by qualified personnel and according to the local safety regulations for spa, especially with regard to electric regulations and to the specific instructions for each facility.

WARNING: The rules in force on accident prevention should be carefully followed.

WARNING: Any modification of the pump requires the prior consent of the manufacturer. Original replacement manufacturer of the pump assumes no liability for the damage and injuries caused by unauthorized replacement parts and accessories.

WARNING: During operation, some parts of the machine are subject to dangerous electric voltages. Work may only be performed on each machine or on the equipment connected to it after disconnecting them from the main and after disconnecting the starting devices.

WARNING: The user should make sure that assembly and maintenance tasks are carried out by qualified authorized persons and that these persons have first carefully read the installation and service instructions.

WARNING: The operating safety of the machine is only guaranteed if the installation and service instructions are correctly followed.

2.3 *Warning for installation and assembly tasks*

Electrical connections

See also the document: **Electrical system, safety distances and danger zones for SPA pools with hydromassage.**

The motor must be wired according the local standards: - if in doubt consult a qualified electrician. Check supply voltage complies with voltage on motor plate.

When connecting electric cables to the motor of the machine, be careful to correctly arrange them inside the connection box, verify that no bits of cable are left inside on closing it, and see that the earth wire is correctly connected.

Be especially careful that no water whatsoever enters the motor or the electrical parts under voltage.

In the event that the planned use is not as specified, adaptations and supplementary technical rules may be necessary.

Warnings for START-UP

Before starting up the machine, verify the calibration of the electrical protection devices of the motor and that the protections against electrical and mechanical contacts are correctly positioned and attached.

Be especially careful that no water enters the motor or the electrical parts under voltage.

Avoid all contact, even if accidental, with the moving parts of the machine.

Wait until the machine has stopped completely before handling it in any way.

Before carrying out an electrical or mechanical maintenance task, make sure that the machine has been disconnected from the mains and that the starting devices are locked.

It is advisable to follow the steps listed below before handling the machine in any way:

1. Turn off the voltage to the machine.
2. Lock the starting devices.
3. Verify that there is no voltage in the circuits, including the auxiliary circuits and the supplementary services.
4. Wait until the rotor stops completely.

The above list should be considered indicative and not binding for the purposes of safety; specific safety rules may exist in particular regulations.

Regularly verify:

- The correct attachment of the mechanical parts and of the support screws of the machine
- The correct position, attachment and condition of the supply cables and of the insulating parts.
- The temperature of the machine and of the electric motor. In event of any irregularity, stop the machine immediately and have it repaired.
- The mechanical sound of the machine. In the case of any irregularity, stop the machine immediately and have it repaired.
- The vibrations of the machine. In the case of any irregularity, stop the machine immediately and have it repaired.

2.4 Connection of your SpaPack (hydraulic & electric)

WARNING: To connect your SpaPack, you must:

- Put the SpaPack on a flat surface.
- Use pipe of 2" diameter.
- Not exceed 3,5 meter.

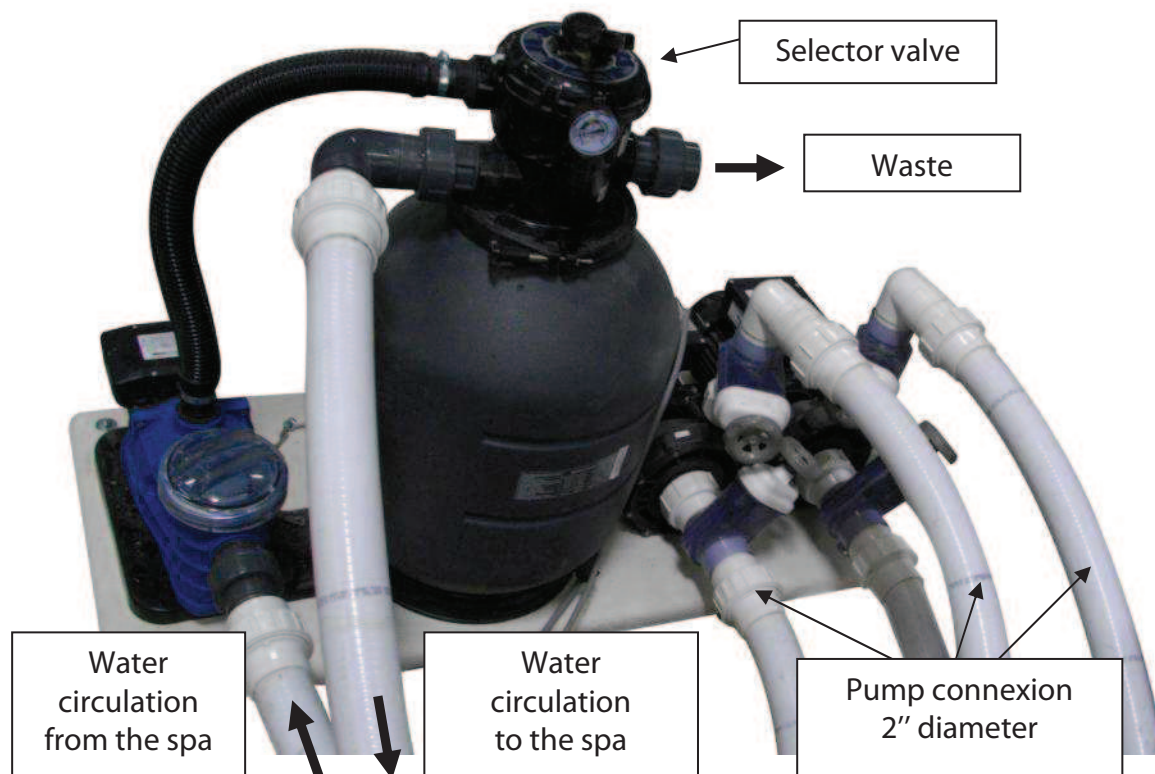

HYDRAULIC CONNECTIONS

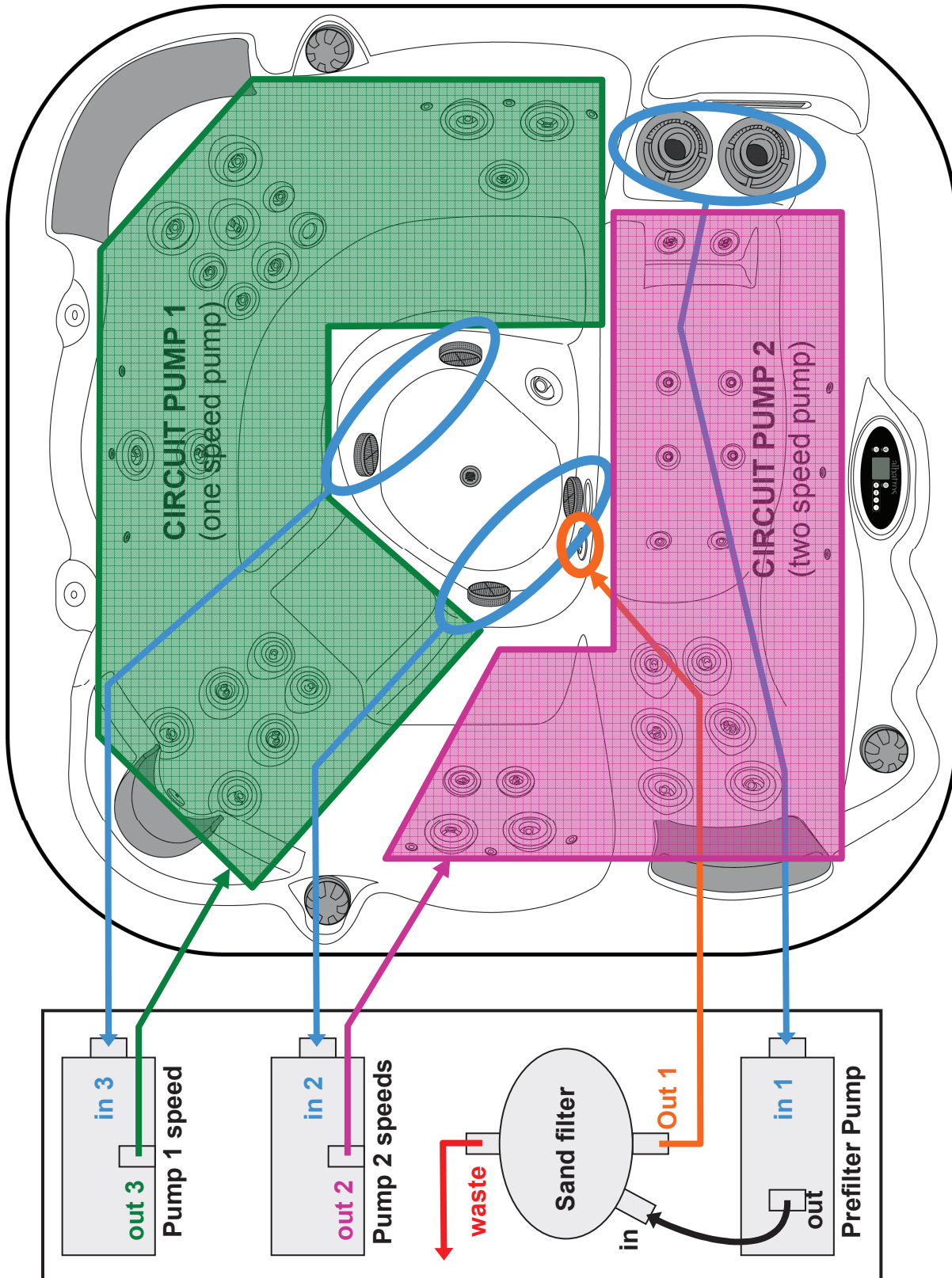

ELECTRIC CONNECTIONS

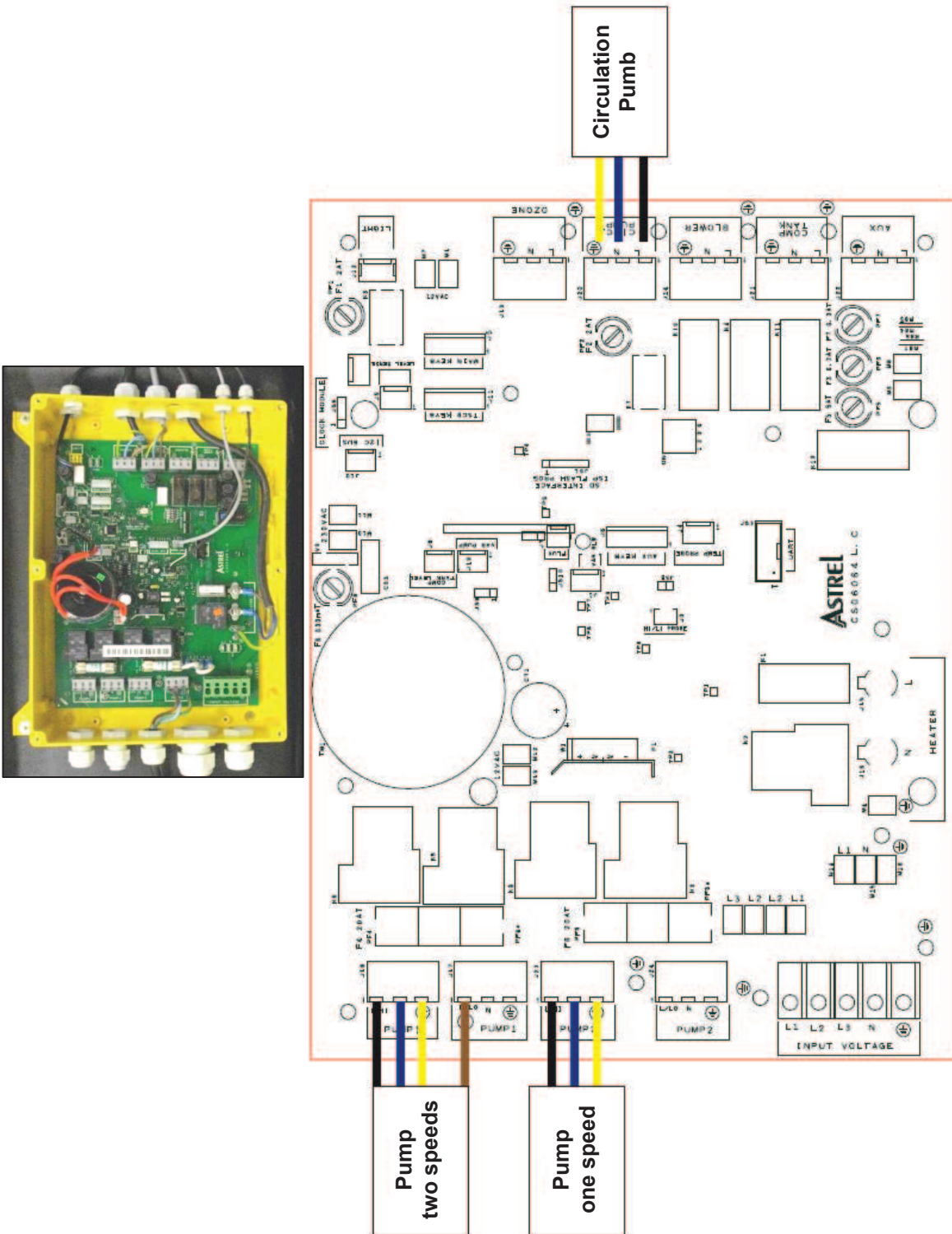

3. Commissioning of spas

3.1 Electrical connections

General characteristics 230V/30A	General characteristics 400V 3N/30A
Voltage: 230 Vac Number of wires: 3 Frequency: 50 Hz Current consumed: see attached table	Voltage: 400 Vac Number of wires: 5 Frequency: 50 Hz Current consumed: see attached table

See also the document: Electrical system, safety distances and danger zones for SPA pools with hydromassage.

Electrical consumption (A)	Pares 230V	Marami 230V	Marami 400V 3N
Max	11,8 A	15,4A	10,5 A
Massage max	11,8 A	15,4 A	10,5 A
Filtration	0,8 A	0,8 A	0,5 A
Filtr. + Heater	11,8 A	11,8 A	8,2 A

Description of electrical equipment room

1	Electrical box	4	Chromotherapy
2	Heater	5	Slide valve
3	Ozone generator		

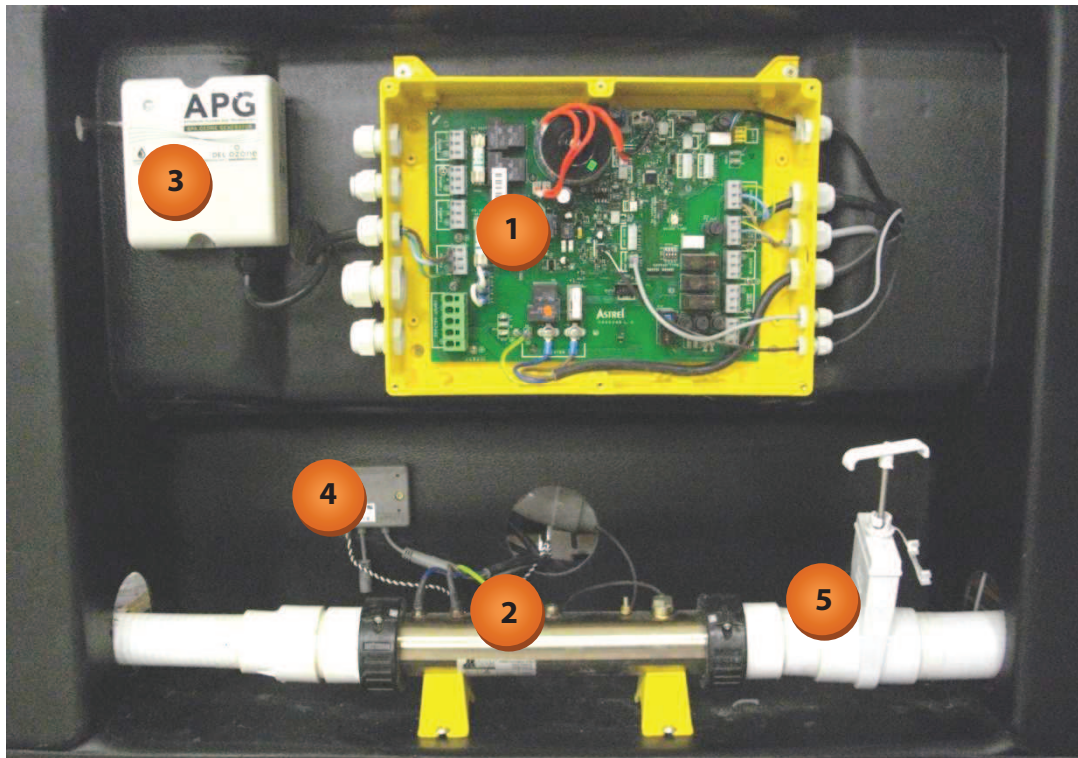

Non contractual photos

Instructions for installation and operation - English

Electrical connection operations (Always use the appropriate tools in order not to damage the components)

In order to access the electrical power cabinet of the spa, remove the screws in the side panel of the spa located next to the electronic control panel of the spa



Then take the screws out of the cover of the electrical box then remove it.



Non contractuels photos

Choose the entry point of the cable on the most suitable side and drill a cable passage of a corresponding diameter either in the base or in the surrounding panel. Put in the power supply cable of 230 volts + ground. This cable must be of a sufficient cross-section in relation to the complete equipment of the spa and protected upstream by a 30 mA differential circuit-breaker (electrical standard C15-100).

Connect the power supply cable up to the terminal pad. **TIGHTEN THE TERMINALS TO THE MAXIMUM ON THE WIRES!** All the wire connections must be really tight failing which damage could occur.

PARES:

Single-phase connection: 230 Vac, 50/60Hz, 32A max.

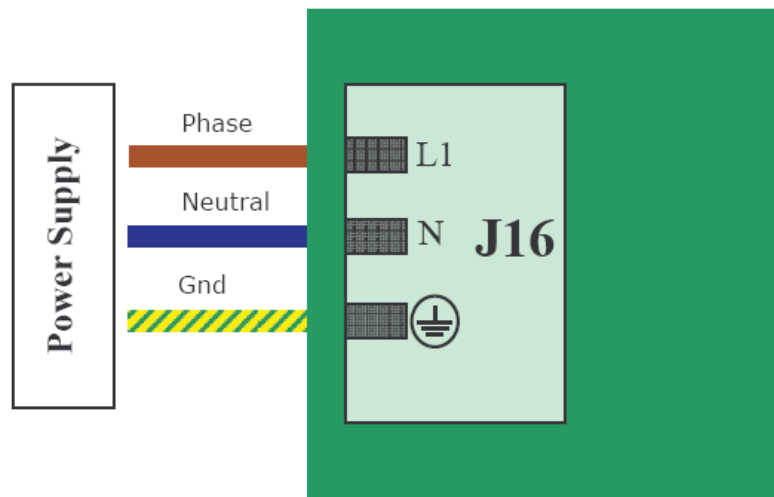

MARAMI:

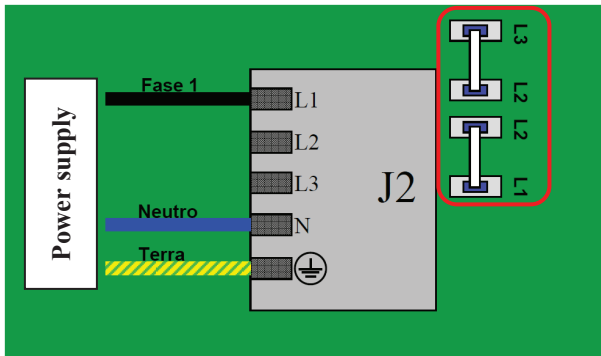

Mono phase 230Vac, 1 x 32A + N 50/60Hz
Indicated jumper **MUST NOT BE REMOVED**

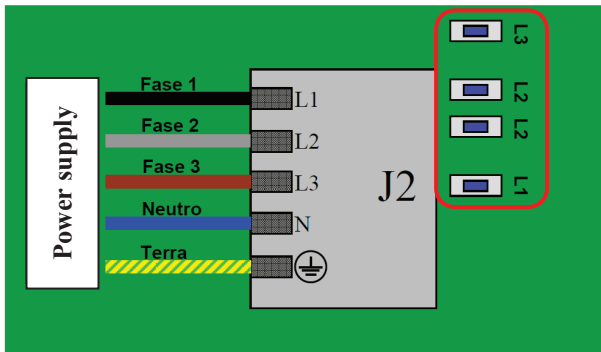

Tri phase 400 Vac, 3x16A + N, 50/60 Hz
Indicated jumper **MUST BE REMOVED**

Put the cover back on the electrical box.

3.2 **Filling the spa**

Only fill the spa at its final location



Open all slide valves by lifting the handles and locked it by sliding the locking clips on the axes of the slide valve to keep them open.



Check that the gravitational drain valve of the spa is closed and that the plug is tight on the valve.

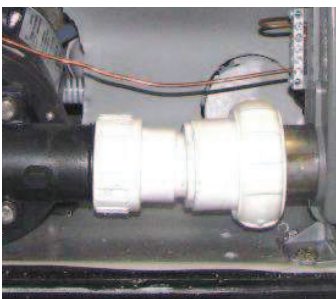

Check that the pump connections are tight. It is possible that vibrations due to the transport may have slightly loosened them.

Instructions for installation and operation - English

Remove the cover from the filter or filters and remove the cartridges from the filter body.



Fill the spa directly via the skimmer in order to facilitate the priming of the pumps.

CAUTION: Do not fill the spa with water from a water softener. If your water is extremely hard, it is preferable to half fill the spa with the hard water and then complete the filling process with the softened water.



Fill the spa directly via the skimmer in order to facilitate the priming of the pumps until the water level covers all the jet spouts, but without reaching the level of the lowest headrest. Avoid over-filling the spa, as it could overflow when users enter it.

Regularly check the water level and adjust it if necessary.

Start the treatment of the water as soon as the spa is full.

IMPORTANT: Always fill the spa via the skimmers. The failure to use this method could trap air in one or other of the pumps preventing the normal circulation of the water. Then remove the hose pipe and put back the two filtration cartridges.

During periods when the spa is not in use, we recommend keeping the cover on it in order to prevent evaporation, heat loss and pollution.

3.3 Switching on the power

Close the circuit-breaker on the home power supply panel. The heating element and the circulating/filtration pump will start up immediately.

Priming of pumps:

Prime the pumps before using the spas:

- It is advisable to first remove the filter cartridges from the skimmer in order to facilitate the priming operation.
- Loosen the bleed cock located on the pump suction (horizontal pipe) in order to discharge the air until water starts running out of it.
- Tighten up the coupling and start the pump. The pump should prime and air escapes for a moment through the massage nozzles.
- Should the pump not prime quickly, stop it and restart the operation.

Depending upon the model, the control panel may have one or two pumps. Prime each pump in the same way. Put the filtration cartridges back in place once the pumps have been primed.

Activation of massage pumps (number of massage pumps depending upon the models):

PARES

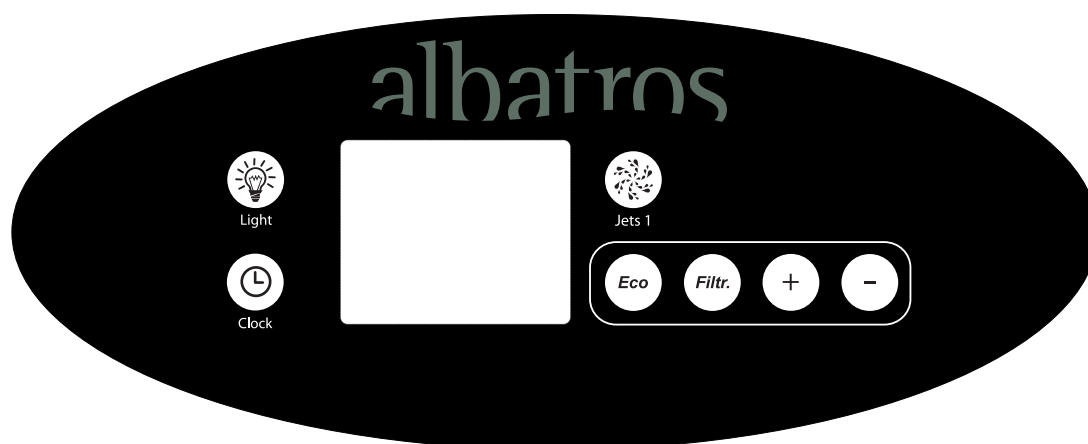

Press the « JETS 1 » key on the electronic control panel once in order to start pump #1.

MARAMI

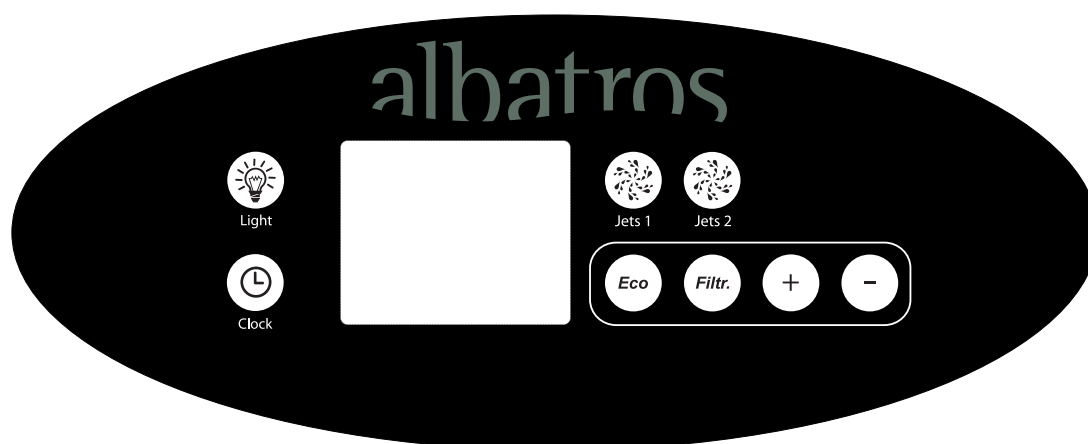

Press the « JETS 1 » key on the electronic control panel once in order to start pump #1.
Press the « JETS 2 » key on the electronic control panel once in order to start pump #2.

Test to see that all the functions are in working order; see page Operation of the spa

3.4 **Installation of the isothermal cover**

During periods when the spa is not in use, keep it closed using its isothermal cover in order to maintain the temperature of the water and reduce the heating sessions and also your consumption of electricity.
In order to enable the cover to be kept in position and prevent access to the spa in the absence of periods of supervision and to protect it from the wind and pollution, we advise you to attach the cover with the lockable cleats supplied with it.



3.5 **Initial treatment of the water**

In order to treat the water, refer to chapter 5.11.

CAUTION: Never add (trichloro) chlorine tablets to the spa water! This chemical could damage your spa and invalidate the manufacturer's warranty.

4. **Use of the spa**

4.1 **Presentation of PARES**

- 1. Headrest
- 2. Adjustable jets
- 3. Diverter valve
- 4. Waterfall
- 5. Filtration
- 6. Ozone discharge
- 7. Dream collar jets
- 8. Chromo spot
- 9. Control panel
- 10. LED
- 11. Suction grid

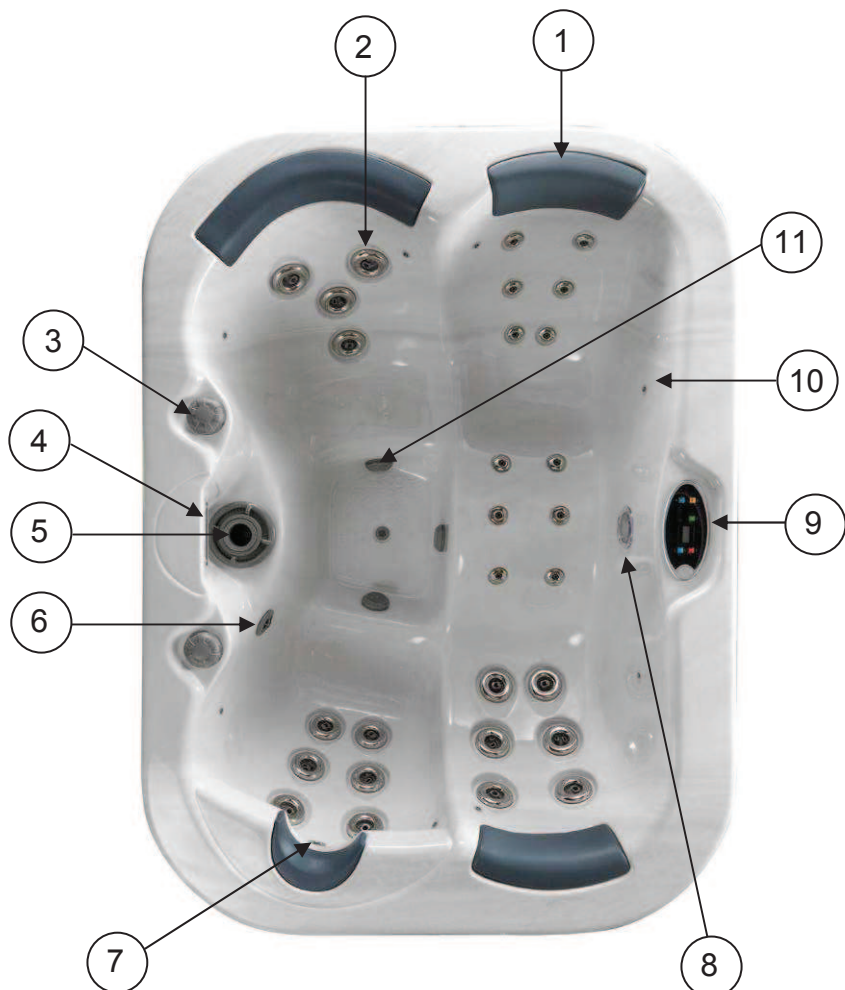

4.2 **Presentation of MARAMI**

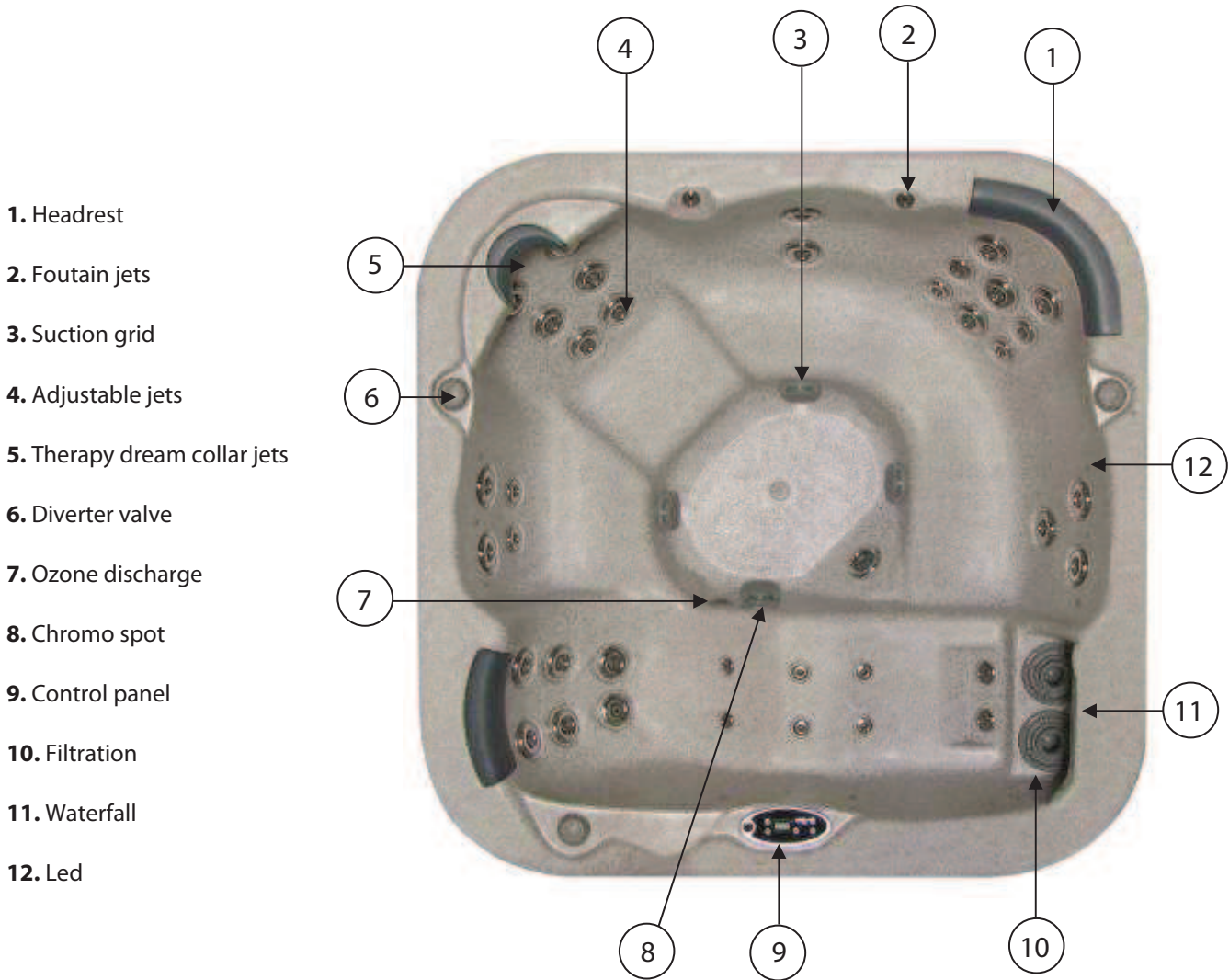

- 1. Headrest
- 2. Fountain jets
- 3. Suction grid
- 4. Adjustable jets
- 5. Therapy dream collar jets
- 6. Diverter valve
- 7. Ozone discharge
- 8. Chromo spot
- 9. Control panel
- 10. Filtration
- 11. Waterfall
- 12. Led





Each pump powers the massage jets in different sectors defined below. Massage pump is a two-speed pump used either for more or less invigorating massage.

Some sectors use the same pump alternately. According to its position, a diverter valve directs the flow from the pump to a particular sector.

Maintaining the diverter valve in an intermediate position between two sectors can create some turbulence in the circuit and make some noise into the jet. This noise can be eliminated by switching diverter valve slightly in one direction or another.

IMPORTANT : Do not close all the massage jets in the same sector. Allow at least three jets must be open to prevent the pumps to force unnecessarily and deteriorate. It is normal that a short time passes between the selection of a series of jets with deviator and the effective output of air bubbles from the valves; such delay is necessary to permit the correct drainage of the longer pipes.



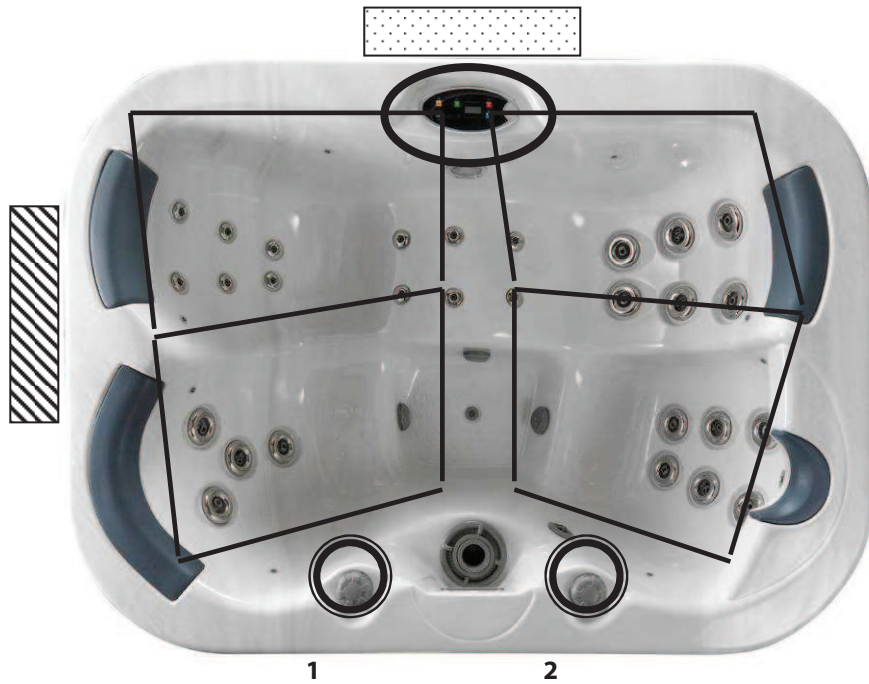

4.3 PARES

-  Diverter valve
-  Control panel
-  Filtration pump
-  Two-speed pump





Diverter valve 1 (on/off) => Waterfall
 Diverter valve 2 (on/off) => Therapy dream collar massage

4.4 MARAMI

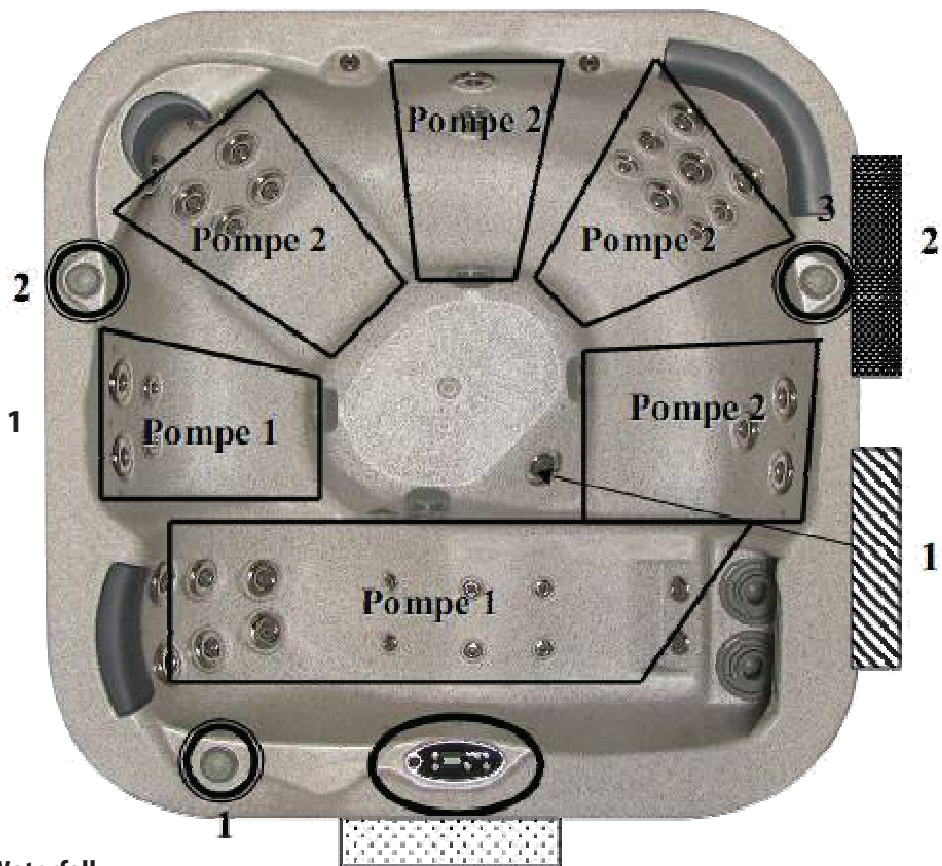
-  Diverter valves
-  Control panel
-  Filtration pump
-  Massage pump 1 two-speed
-  Massage pompe 2

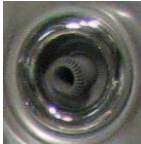

Diverter valve 1 (on/off) => Waterfall
 Diverter valve 2 (on/off) => Therapy dream collar massage
 Diverter valve 3 (on/off) => Foutain jets

	Designation	Description
	Diverter valve	To direct the flow of a pump to one sector or another.
	Adjustables jets 70 mm et 90 mm	Adjustable massage jets fixed in direction. The flow of each jets is adjusted by rotation of its outer ring.
	Simple rotary jets or double jets	Rotary massage jets. The flow of each jet is adjusted by rotation of its outer ring.
	Mini jet	Fixed non-adjustable jet flow. Jet fixe non réglable en débit.

4.5 **Operation of the sand filter (Marami with SpaPack only)**

INSTALLATION

Make sure there is drainage available at the place where the filter is to be installed.

Do not use an iron and hemp pipe for the selector valve connection, it is essential to use plastic accessories and TEFLON tape. Always leave enough space round the filter in order to perform the necessary examinations and maintenance during the filter's life.

SAND LOAD

In order to obtain maximum efficiency from your filter, it should be filled with silica sand with a grain size classification between 0,5mm and 0,7mm. With the quantity indicated on the plate specifying the characteristics; proceed as follows:

1. Load up when the filter is installed in position and the connection pipes have been joined.
2. Take off the lid and joint.
3. Fill the filter with water to half capacity.
4. Pour the required quantity of sand inside the filter.
5. Clean the seating of the lid joint
6. Fix the filter lid in place

FILTRATION PROCESS

The selector valve has a handle of 6 positions that selects any of the necessary operations to obtain the maximum efficiency from the filter.

IMPORTANT: always switch off the pump, when changing the position of the selector valve.

When the filter has been loaded, the sand must be washed. Proceed as follows:

1. Place the selector valve in the « BACKWASH » position.
2. Open the valves controlling the swimming pool suction pipes and run the pump for 4 minutes.
3. Stop the pump, place the handle of the selector valve into the « RINSE » position and rinse for 1 min. Then, stop the pump and place the handle of the selector valve into « FILTER » position.

When this has been done, the filter will be ready to start.

➤ **FILTRATION**

With the pump switched off, place the handle of the selector valve in the « FILTER » position.



Switch on the pump.

During this operation, it is advisable to observe the pressure gauge from time to time as this indicates the degree of the filter. When the pressure reaches 18.5 PSI a « BACKWASH » should be carried.



0,8kg/cm² - 11,4 PSI :
Normal pressure at the beginning of a filtering cycle.



1,3kg/cm² - 18,5 PSI :
This pressure indicates that it is necessary to backwash.

➤ **BACKWASH**

Each load of sand forms thousands of channels which pick up all the material contained and caught up in the filtering process, the number of free channels allowing the water to pass is continually decreasing. This is why the pressure rises progressively until it reaches 1,3 Kgs/cm². At this pressure the filtering sand is unable to collect any more impurities and must be cleaned as follows: Turn the selector valve to the “BACKWASH” position and with the main drain and return valves open, switch on the pump and run it for 2 minutes. When this operation is completed, the dirt blocking the filter will have been removed

Attention: Too much time in this operation could cause damage to the filter collector unit.



➤ **RECIRCULATE**

In this position, the selector valve allows the water from the pump to go directly to the spa without passing through the inside of filter.



➤ **WASTE**

If the spa needs to be drained, this can be done using the filter pump. In order to do this, the selector valve should be in the « WASTE » position. The motor is run with the main drain valve fully open, for the pump to have sufficient suction. For the pump to suction, keep the préfiltre and the main drain pipes full of water.

Before drainage, make sure that the valves and the bottom cleaner valves are closed.



➤ **RINSE**

After the carrying out the « BACKWASH » operation on the filter and placing the installation in the « FILTER » position, the water flowing into the spa will be cloudy for a few seconds, so to prevent it from reaching the spa is a « RINSE » position for the selector valve which is operated as follows: immediately after the “BACKWASH” put the valve in the “RINSE” position and switch on the pump for 1 minute, after which the pump is switched off and the valve placed in the “FILTER” position. This position ensures that the filtered water goes directly to the drain.

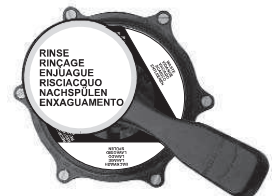

➤ **CLOSED**

As its name indicates, this position is for closing off the water from the filter to the pump and it is used for opening the collector prefilter pump.



MAINTENANCE

Do not use solvents for cleaning the filter, this could damage the filter, especially its finish.
 Always replace the joints and pieces that may not be in good condition.
 Backwash and rinse when needed, as per the instructions specified in this manual.
 Clean the sand every year for a better performance. It is recommended to change the sand inside the filter approximately every 3 years.

WINTER PERIOD

In order not to damage the filter during the winter period, please follow the instructions below:

- Perform a backwash and a rinse as previously detailed
- Remove the water from the filter
- Take off the lid to ventilate the filter in the period of inactivity
- When you need to start up the filter again after a period of inactivity, follow the instructions stated in the paragraph « FILTRATION PROCESS »

THE MOST COMMON PROBLEMS

EFFECT	POSSIBLE CAUSE	SOLUTION
The filter only provides a small volume of the filtered water. Vacuum heads have poor suction.	Prefilter blocked.	Clean the filter
	Motor turning the wrong way	Check by the arrow on the body of the prefilter which way the motor is turning, if this is not correct, reverse the motor connection
	Suction pipes are blocked	Proceed to clean
The pressure rises rapidly during a filter cycle	Water pH is high (cloudy water)	Decrease the pH
	Lack of chlorine (greenish coloured water)	Add chlorine
The pressure gauge varies considerably	The pump is taking in air	Check for leaks in the prefilter and suction pipes
	Suction is half closed	Check that the suction valves are completely open

4.6 Operation of the prefilter pump (Marami with SpaPack only)

Before start-up, open the transparent lid and fill the pump and filter basket with water.

➤ START-UP

Check that rotation direction of motor coincides with the direction as marked on the pump casing.

Important wrong rotation can cause serious damage within 15 minutes.

If pump does not prime after a few minutes refill pump with water.

➤ WINTERING

If there is any risk of freezing, completely empty the pump by the two drain lags of the casing of the pump.

➤ START-UP INSTRUCTIONS

Before starting the pump carry out the following operations:

1. Take off the préfiltre cover
2. Fill up the pump with water through the préfiltre until it dips into the suction tube.
3. If during this operation the basket has been taken out, do not forget to replace it inside the préfiltre to prevent large particles from entering the inside of the pump specification board.
4. Check that the voltage and network power correspond to those indicated on the pump specification board.
5. Put back the cover on the préfiltre and screw it until closed, without forgetting to place the joint in its housing.
6. For plugging, please read the indicated drawing on the engine junction box.

7. STARTING A THREE PHASE PUMP

Check the direction of rotation (fan cover removed) before switching on by giving a momentary electric pulse to the motor.

This check must be performed with no water in the pump casing.

A three phase pump running backwards can be destroyed in a few seconds.

If rotation is in the wrong direction, change over 2 phases of the power supply line. An arrow labeled (➡) on the top of the pump's wet end clearly shows the right direction of rotation. When the direction of rotation is correct, the pump may be filled with water.

Open all valves and switch on the motor. Wait few minutes for the priming.

THE MOST COMMON PROBLEMS

EFFECT	POSSIBLE CAUSE	SOLUTION
The pump does not prime	Air entry in suction tube	Check up pipe fittings and suction tube joints
	Bad filter cover sealing	Clean up the prefilter cover and check up the condition of the joint
	Motor turning in the wrong direction (only for 3 phases pumps)	Invert the two phases of the feeding line
	Hydraulic network not well dimensioning. Too much load loss	Start the pump with the prefilter full of water with outlet valves totally closed, then open it progressively.
The pump gives low flow-volume	Blocked prefilter	Clean up the prefilter
	Air entry in suction tube	Check up pipe fittings and suction tube joints
	Motor turning in the wrong direction (only for 3 phases pumps)	Invert the two phases of the feeding line
	Load loss in suction	Prevent as much as possible elements that produce load loss
	Wrong voltage	Check that the network voltage corresponds to that on the motor specification board
The motor stops	Pump overheating	Verify distance between motor and wall. Must be over than 10 cm.

4.7 Operation of the spa

Initial start-up

On switching on the spa, you will have a sequence of figure + letter (probe test ...) that will last for a few seconds. Then the display will flash between the instantaneous temperature and the time.

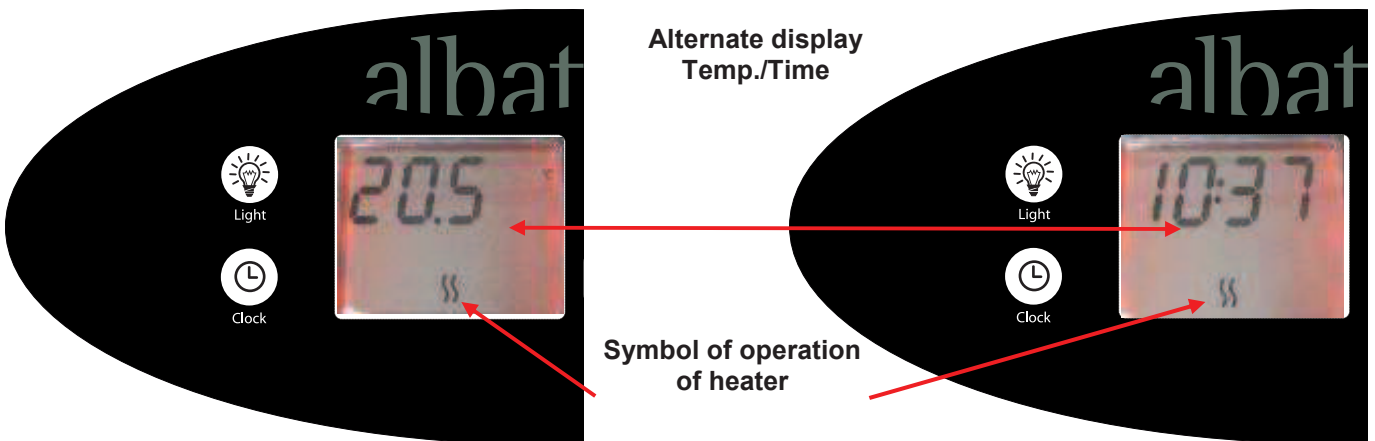

Then press the « Jets » button(s) several times and make sure that all the pumps have indeed been primed (discharge of air).

PARES

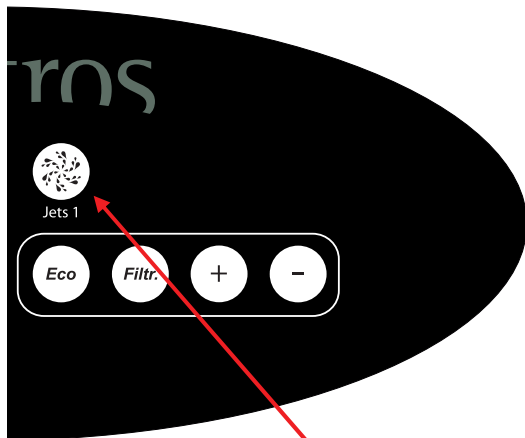

1 : Press Jets 1 button to ensure priming has taken place

MARAMI

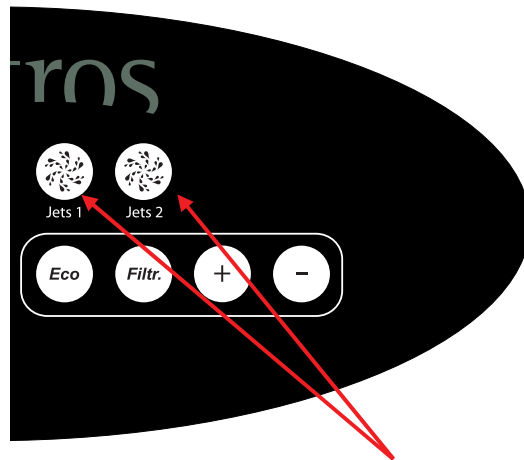

1 : Press Jets 1 button then Jets 2 button to ensure priming has taken place

Temperature check (15°C – 40°C)

The water temperature displayed is always the last temperature measured.

In order to display the temperature, press once on the buttons + or -. To change the temperature all you have to do is to press again on the keys + or -.

After 5 seconds, the display will return to normal provided no key is pressed.

The setting of the thermostat to its maximum temperature will not speed up the rise in temperature. The temperature rise should be 1°C per m³/h

- 1 : Press to display the temperature**
- 2 : Press again to change the temperature**



Temperature display symbol

Advice: it is preferable in the interests of energy saving to maintain a constant water temperature in order to limit the occurrence of big temperature fluctuations which result in an increase in electricity consumption.

Jets 1, Jets 2 (if fitted)

Press the **Jets 1** key in order to switch on pump 1 (slow speed). To switch from low speed to fast speed press the **Jets 1** key a second time.

Pressing a third time will bring the pump to a stop.

Press **Jets 2** to start pump 2. Pressing a second time will stop the pump (**MARAMI ONLY**).

The pump will automatically stop after 20 minutes of continuous operation.

The operation of the pumps may be influenced by the presence of a level detector

Display of pump 1

Press to actuate pump 1 at low speed

Press a second time to actuate pump 1 at high speed

A 3rd press will stop the pump

MARAMI ONLY:

The symbol flashes for low speed and remains lit for high speed

Press once to actuate the pump. Press a second time to stop it.



Chromotherapy

Press the **Light** key to switch on the chromotherapy illumination of the spa.

Press a second time to switch it off.

It will automatically go off after 2h of continuous operation. To change the sequence, press again on the « **Light** » key.

Switching on of chromotherapy

Display of chromotherapy



Depending upon the versions, whenever you press, a fresh colour and/or automatic sequence of different colours appears.

Filter function

The Filtr. key enables you to programme your filtration time. To do that, press the Filtr. key then set the time by pressing the + or – key on the keyboard. Setting is done on the basis of a number of hours with a maximum of 12h.
 e.g. if you opt for Fd 2 your filtration will operate 2h every 12h.

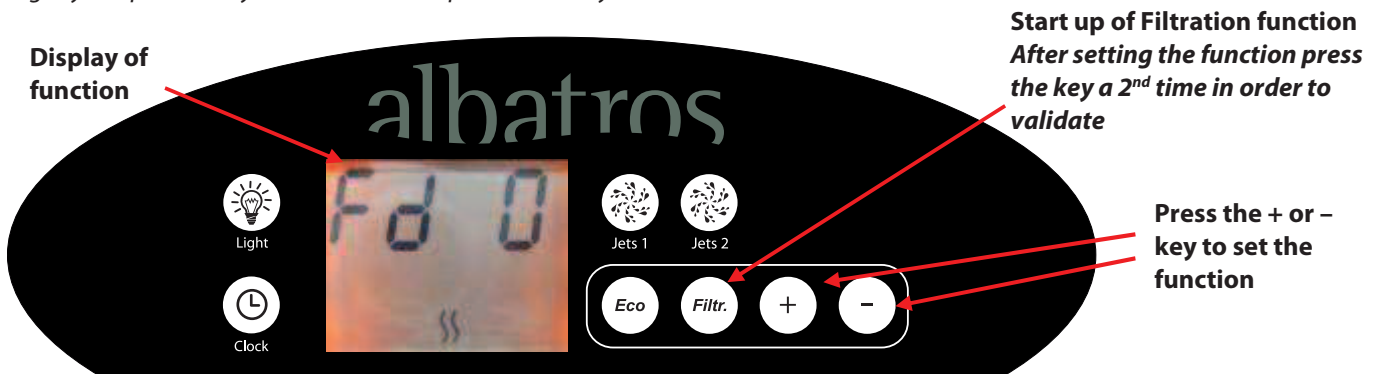

Accelerated Filtration Function

This function enables you to activate the accelerated filtration procedure for a limited time. All the pumps start up as well as the ozonator for 45 min. To activate this function all you have to do is to press on the **Jets 1** button for 5 sec.



Eco Function

The Eco function enables you to save energy by maintaining the temperature of the water 10°C below the programmed value. In all cases the minimum temperature permitted is 15°C.

To start the Eco function all you have to do is press the **Eco** key on the keyboard.

The default value Ed 10 will appear which corresponds to a 10h duration of the function.

It is possible to set the function between 0h and 24h (in intervals of one hour). To do that all you have to is press the + or – key during the display of the function and press a second time on the **Eco** key in order to confirm the function.

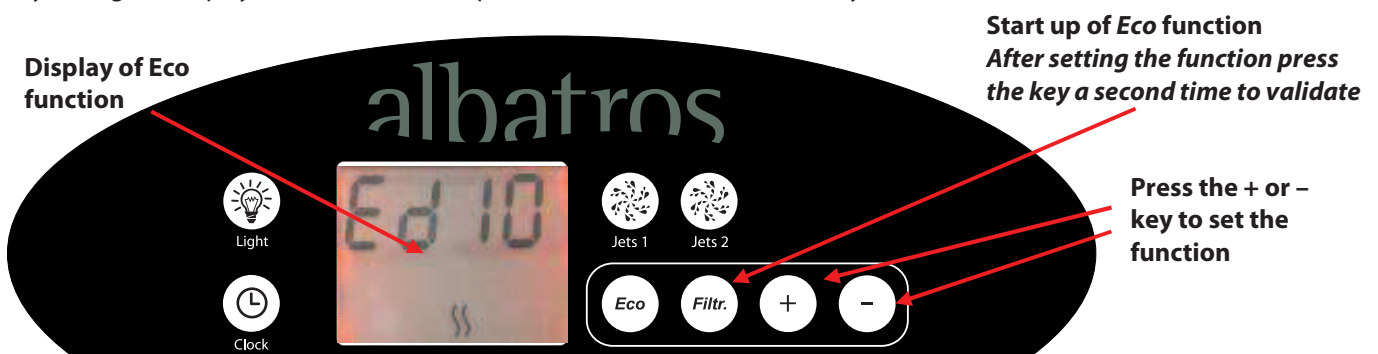

Start timing programmation Filtr. and Eco functions

It is also possible to adjust the start time of your filtration and your Eco mode. To do this, press once on the Filter button or Eco. (depending on whether you want to set the time of programming or filter your eco mode) then a second time. You will see the time display flashes. Therefore set the time using the + and - keys on the keyboard. To set the minute press again on the Filter button, or Eco then adjust using the + and -. Finally confirm by pressing a last time the button Filtr. or Eco.

Stand-By Function

This function enables you to do maintenance work on the spa by changing the filtration cartridges while blocking all the functions for a period of 60 min. without having to disconnect the spa.

The Stand-By function is activated by pressing the **Filtr.** key for 5 sec. (once the function has started you have to wait 30 sec for everything to come to a stop). When the function is activated, you will see displayed alternately on the screen the message **Sby** and the time remaining in minutes.



Programming of the clock

- Press on the « Clock » key for 5 seconds until the time displayed starts flashing.
- Use the keys + and - to set the value of the hour, then press again on « Clock » to change the minutes. Likewise use the keys + and - to set the minutes.
- Lastly validate the programming by pressing the « Clock » key.

Locking of keyboard

This function enables you to lock your keyboard in 2 different ways, either completely or partially.

Partial locking enables you to block all the « programming » part, i.e. all the keys at the bottom (Clock, Eco, Filtr., +, -)

As for total locking it blocks the entire keyboard.

Partial locking:

LocP is displayed together with a key symbol

Press on the Eco key for 3 seconds

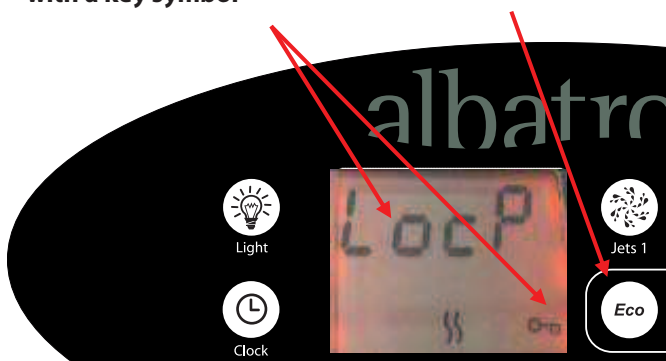

Total locking:

LocF is displayed together with a key symbol

Press on the Eco key for 5 seconds. You will see LocP appear then by keeping it pressed LocF will be displayed



Unlocking of the keyboard:

ULoc is displayed



Press on the Eco key for at least 5 seconds.

Reversal of display

This function enables you to rotate the display on the control panel in order to be able to read it directly from inside the spa. To do this all you have to do is to keep the Light key pressed for 5 seconds. The function is de-activated in the same way.

Press 5 seconds
on the Light key.



5. Maintenance of the spa

5.1 Cleaning the cartridges

Your spa is fitted with two high quality filtration cartridges located inside the body of the skimming filter (skimmer). Fine particles are filtered through the water suction effect created by the pump through the filtration cartridges. These cartridges require periodic cleaning and even replacement if necessary.

The cleaning frequency may vary from one spa to another according to several criteria (installation indoors or outdoors, the number of users, the frequency with which it is used, the temperature of the water...). We recommend initially checking the cartridges every week if the spa is outdoors and every fortnight if it is indoors. Subsequently, depending upon the degree of clogging of the cartridges, the user will be able to decide him/herself what frequency is best suited to his/her particular case. A drop in output of the massage nozzles of the sectors of pump 1 is a typical sign of clogging of the filter cartridges and therefore of the need to clean them.

BEFORE CLEANING THE FILTRATION CARTRIDGES, ALWAYS SWITCH OFF THE SPA POWER SUPPLY!

5.2 Draining and filling the spa

WARNING! READ THE FOLLOWING INSTRUCTIONS BEFORE DRAINING THE SPA: In order to prevent any damage to the components of the spa, **switch off the power supply by opening the circuit-breaker on the power supply circuit before draining the water** and do not switch the power back on again until the spa has been filled again.

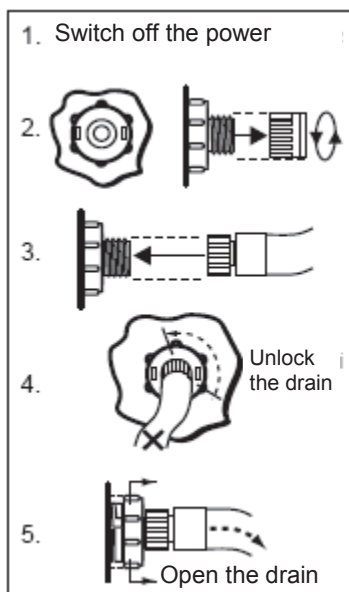

CAUTION: Remember that various measures may need to be taken when draining your spa. If the spa is outdoors and there is the possibility of a frost, refer to the chapter 5.7 entitled «WINTERIZING». And, on the contrary, if the weather is very warm, do not expose the inside walls of the spa to direct sunlight.

To drain your spa, proceed as follows:

1. Open the circuit-breaker on the spa power supply circuit.

2. Locate the drain valve at the bottom on the front panel. Hold its (bigger) rear part firmly to prevent it from turning, then unscrew and remove the plug so that the thread for the hose pipe is exposed.

3. Connect up a garden hose.

4. Slowly turn the rear part of the valve 1/3rd of a rev in an anti-clockwise direction to unlock the valve.

5. Pull outwards this bigger part (rear) in order to open the valve.

6. After draining the spa, do steps 2 to 5 again in reverse order to close the valve again before refilling the spa.

Before filling the spa, close the circuit-breaker on the power supply circuit and follow the «Method for filling the spa».

5.3 **Upkeep of the inside surface of the spa**

In order to retain the fine appearance of this surface, apply the following advice:

- Use common household products that are NON-ABRASIVE for most of the cleaning work. Thoroughly rinse and dry with a clean rag.
- NEVER use abrasive cleaning materials.
- Do not use with products such as acetone (dissolvent), nail varnish, dry cleaning products, lacquers, wood turpentine, etc...
- Remove dust and dry dirt with a soft, damp cloth.
- Clean off grease, oil, paint and ink stains with isopropyl alcohol applied with a soft rag.
- Avoid using razor blades or any other sharp instrument that could scratch the surface. Small scratches can be removed by applying a fine coat of polish (for car bodywork) and lightly polishing with a clean cloth. For deep scratches, rub the surface lightly with water paper of grain size 400 (moisten the paper with water). Finish off with a fine-grained water compound (1000 or 2000) and apply polish to make the surface glossy.
- All the accessories of the tank (suction parts, massage jets, deviation valve...) must be cleaned exclusively with a sponge soaked in water.
- We recommend always using the isothermal cover for the spas installed outdoors. It provides protection for the acrylic tank against the variations in temperature between the immersed part and the part above the water level.

If you are not sure whether a particular product is adequate for the surfaces of your spa, consult your authorized dealer. Furthermore, make sure that any traces of any product used are rinsed off the surfaces of the spa. This could result in foaming on the surface of the water of the spa.

It is normal, as a result of the thermoforming process used to manufacture the tank, to observe the following features:

- a slight bleaching of the deepest parts of the tank.
- a variation in the height of the edge of the spa of ± 6 mm.
- slight undulation on the top part, due to the shrinkage of the polyester reinforcement.

5.4 **Upkeep of headrests**

If need be remove the headrests and clean them in soapy water with a cloth or soft brush. In the event of shock treatment of the spa water, always remove the headrests. The headrests can be put back once the sanitation reading of the water drops below 5 ppm.

Take care to remove the headrests slowly so as not to damage the inserts.

5.5 **Upkeep of the spa cover**

Covering the spa with its insulating cover when it is not in use will enable a significant reduction in the heating times, the maintenance demands and the operating costs. The cover has in fact several functions:

- preservation of calories and saving of energy
- preservation of the products
- prevention of pollution
- safety for young children
- protection of the acrylic tank

In order to prolong the service life of the cover, handle it with care and clean it regularly with mild soap and water. Never allow anyone to sit or walk on the cover and do not drag it over rough surfaces.

We recommend always keeping the isothermal cover in place when the spa is not in use.

5.6 **Upkeep of the surround made of synthetic material**

The synthetic surrounds of your new spa require very little or virtually no upkeep whatsoever. In order to clean them, simply wipe them with a clean towel soaked in a solution of mild soap and water.

5.7 **Winterizing**

Under normal operation your spa is designed to automatically prevent the water from freezing. During freezing weather, regularly check that the power supply is present at all times and in the event of temperatures of extreme cold of under -29°C , choose the normal skimming/heating mode to prevent the water from freezing.

If you plan not to use your spa or in the event of a prolonged power failure during freezing weather, it is important to drain all the water from the spa and its equipment in order to protect them from frost damage.

5.8 **Restarting your spa during the cold season**

If you wish to restart your spa after it has remained empty under freezing conditions, remember that the water remaining in some sections of the piping may still be frozen. This will block the circulation of the water and prevent the normal operation of the spa and could damage its equipment. We advise you to consult your dealer before trying to restart your spa under these conditions.

5.9 **Preservation of the quality of the water**

The preservation of the quality of the water within recommended limits will contribute to your comfort and prolong the life of the spa equipment. This is a simple task but one that requires regular attention because the chemistry of the water to be complied with depends on several factors to be balanced. There is no magic formula and this task cannot be avoided. A nonchalant attitude to the maintenance of the water will lead to a poor condition of the water which could become unsuitable for bathing and even damage your spa. In order to obtain specific advice about the preservation of the quality of the water, consult your dealer who will be able to recommend the appropriate chemicals required for the maintenance and health of your spa water.

CAUTION: *Never store the spa chemicals inside the surrounds of the spa.*

5.10 **Checking of the pH of the water**

The pH is a measurement of the relative acidity or alkalinity of the water and is measured on a scale of 0 to 14. The median value is 7 and is defined as neutral.

The highest values are alkaline and the lowest values are acid.

It is important to maintain the pH of the spa water between 7.2 and 7.4 in order to achieve effective sterilisation and prevent irritation to the skin of the users.

Do a pH analysis regularly then raise it or lower it accordingly. Adjust by only adding small quantities of chemicals in order not to go too far in the other direction.

IT IS VERY IMPORTANT TO MAINTAIN THE WATER OF THE SPA IN A SLIGHTLY ALKALINE CONDITION BETWEEN 7.2 AND 7.4 IN ORDER TO ACHIEVE EFFECTIVE STERILISATION AND PREVENT IRRITATION TO THE SKIN OF USERS.

The further the pH moves away from this range, the more serious the problems will become (proportionally). A low pH will be corrosive for the metal of the spa equipment.

A high pH will cause the depositing of minerals on the inside walls of the spa (scaling). Furthermore, the ability of the chemicals to keep the spa clean is affected by pHs outside the recommended range. This is the reason why in addition to chemicals most of the maintenance kits for spas contain an instrument for measuring the pH of the water.

5.11 **Purification of the water**

In order to destroy the bacteria and the organic compounds in the spa water, the addition of chemicals must be regularly repeated.

We recommend you use chemicals with an active oxygen base. Several other additives are also available for your spa. Some are necessary to compensate for the imbalance of the chemical proportions and others are treatments of a cosmetic nature or for changing the sensation or the smell produced by the water.

CAUTION: *Do not use (trichloro) chlorine tablets in your spa. This chemical may have an extremely corrosive effect on some materials used in your spa. Any damage caused by the use of this chemical or by the improper use of other products are not covered by the warranty of the spa.*

5.12 **Discharge ozonisation system**

As our spas are fitted with a water purification system using ozone extracted from the air, the spa water will require much less chemicals in order to remain healthy and clear and the intervals between the water draining required will be longer. The discharge ozonator operates jointly with the circulating pump.

Ozone is a powerful oxidant and disinfectant which will assist the sterilisation of the water and enable a reduction in the quantity and the cost of the sterilising products. The ozonator starts up automatically during the periods of filtration of the spa. The reaction time for the ozone is approximately 1/10th of a second and the treatment of the water is therefore done in the piping and the ozone no longer has any effect when it is discharged through the nozzle. The maintaining of a satisfactory pH and an adequate level of steriliser is essential. The ozone assists the chemical treatments but is not a substitute for them. Replace the ozonator after 3 to 4 years depending upon the level of use. Bubbles would continue to be released through the ozone return nozzle, but would no longer have any effect if the ozonator were not replaced.

It is strictly prohibited to use hydrogen peroxide for the chemical treatment of the spa water. This may result in damage to the tank itself and all the accessories made of plastic. It is also strictly prohibited to use pure bromine. Ask for advice from your dealer who will propose solutions based on bromine, chlorine or active oxygen tailored to your spa.

Never put chemicals directly into the spa's tank. Always pour them or put them into the basket of the skimmer, so as to prevent any risk of damaging the acrylic tank.

We recommend draining the spa regularly and filling it with « fresh » water; the frequency of this operation may vary between one and two months depending upon the number of users and the frequency with which they use it.

6. Limited warranty

The spas in our range are covered by a limited warranty. This only protects the original purchaser of the spa.

See the following document: **CONDITIONS OF WARRANTY**

Cover

Deformation linked to an overloading of the cover is not guaranteed.

Wood surrounds

The wood used for the surrounds of portable spas is natural mahogany. Wood is a living material and consequently colour variations in the slats are natural and normal. Wood works as a function of the environment.

Installation and use

This warranty will be null and void for damage resulting from the operation of the spa at a temperature outside the range 1°C to 42°C, the operation of the spa below 230V or above 240V, damage caused by dirty or clogged up filters, damage caused by the use of water that is chemically imbalanced or with an inappropriate pH. Avoid exposing the spa to direct sunlight when it is empty as this can cause overheating of the acrylic surface resulting in delamination (peeling) or blistering.

7. Fault finding guide

Message	Meaning	Solution/Recommendation
	No message displayed. The spa is not switched on	The control panel will be de-activated as long as the spa is not reconnected. The spa settings will be kept until it is switched on again.
FLC	Heater de-activated. The flow/pressure gauge indicates the presence of a flow that should not be present.	Contact your dealer
FLO	Heater de-activated. The flow/pressure gauge does not indicate the presence of a flow that should be present.	Contact your dealer
HOH	Alternate display of temperature of the spa or the time. Detection of a temperature of $\geq 55^{\circ}\text{C}$. The heater stops	DO NOT GO INTO THE WATER. Remove the cover from the spa and let the water cool down.
ICE	Antifreeze cycle in operation – Cyclic activation of the pumps for one minute – the frequency of operation depends on the temperature	DO NOT GO INTO THE WATER. Allow the antifreeze programme to continue.
rPF	Temperature of the water is outside the range $0^{\circ}\text{C} - 60^{\circ}\text{C}$	Contact your dealer